

### **Cabo de aço**

Cabo de aço de 6 ou 8mm

### **Refª 105**

Carro simples porta abraçadeira

### **Refª 106**

Carro duplo porta abraçadeira

### **Refª 163**

Fixador

### **Refª 113**

Carro porta cabos intermédio

### **Refª 114**

Carro porta cabos intermédio

### **Refª 124**

Carro porta cabos guia

A

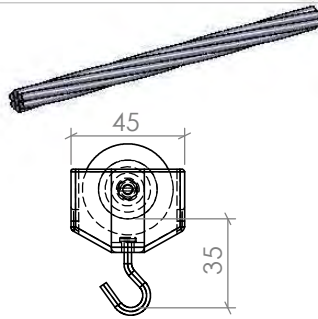
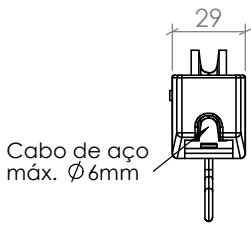

B

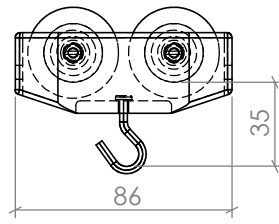
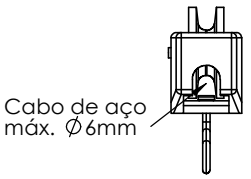

C

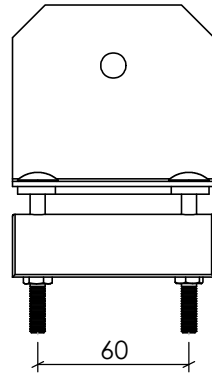
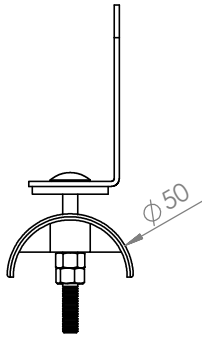

D

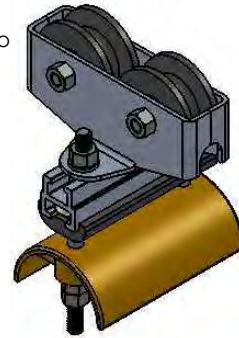
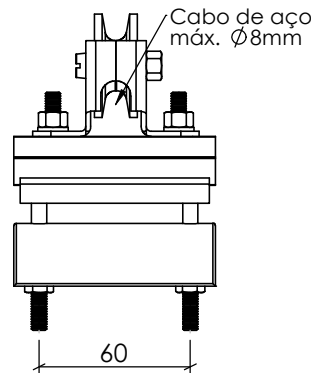
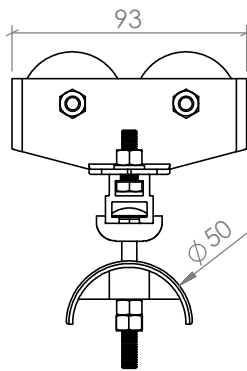

E

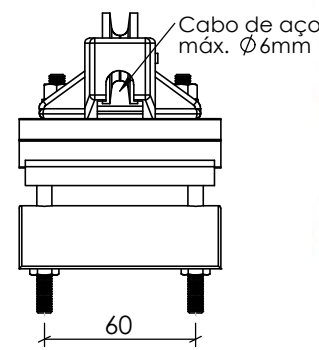
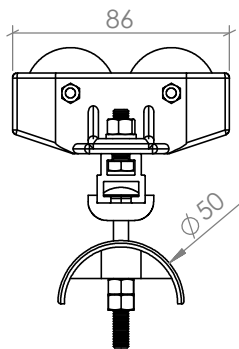

F

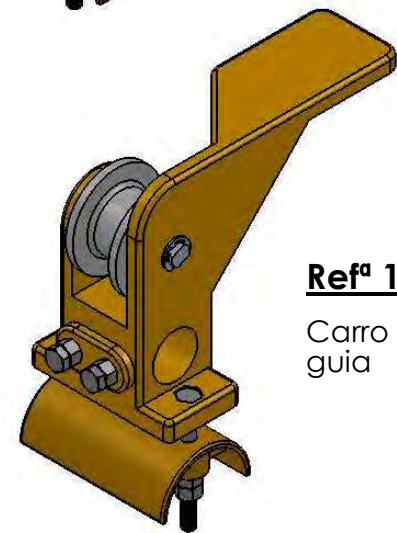
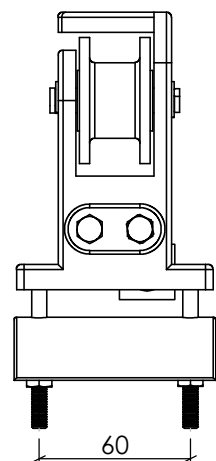
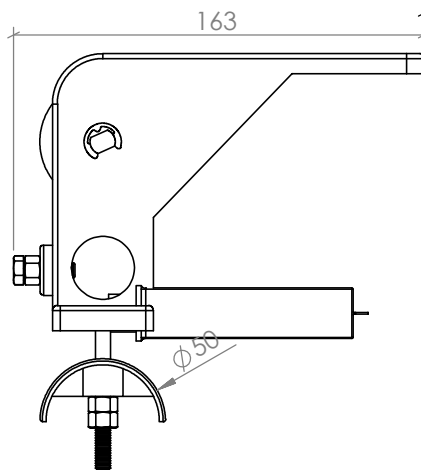



**Cabo de aço**

Cabo de aço de 6 ou 8mm

A

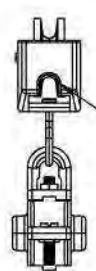

Cabo de aço máx. Ø6mm

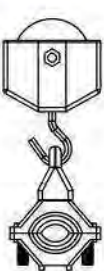

**Refª 105/140 ou 141**

Carro simples porta abraçadeira

B

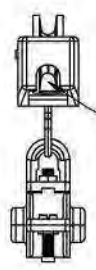

Cabo de aço máx. Ø6mm

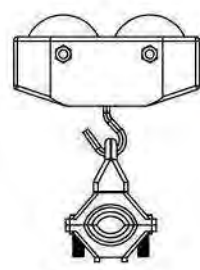

**Refª 106/140 ou 141**

Carro duplo porta abraçadeira

C

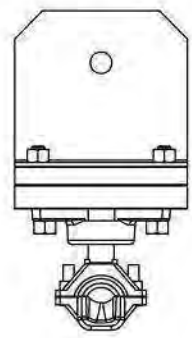
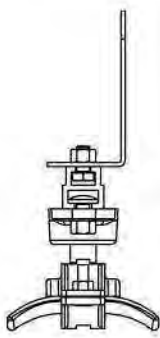

**Refª 163/130 ou 131**

Fixador

D

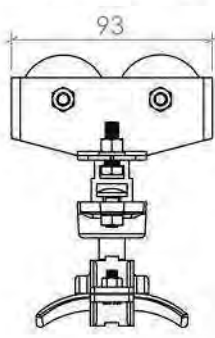

93

Cabo de aço máx. Ø6mm

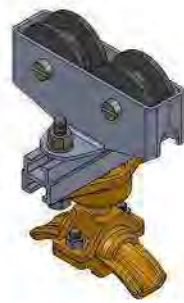
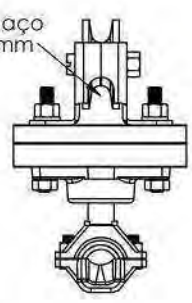

**Refª 113/130 ou 131**

Carro porta abraçadeira cabo redondo guia

E

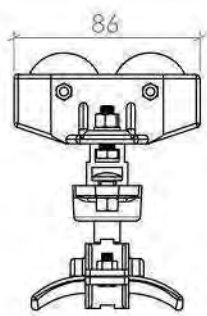

86

Cabo de aço máx. Ø6mm

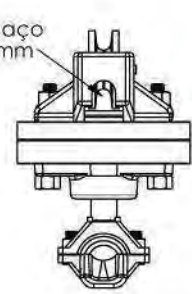

**Refª 114/130 ou 131**

Carro porta abraçadeira cabo redondo guia

F

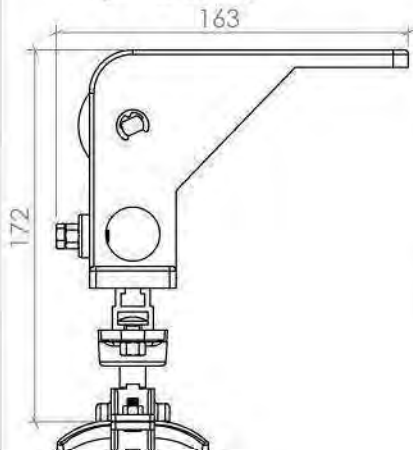

172

163

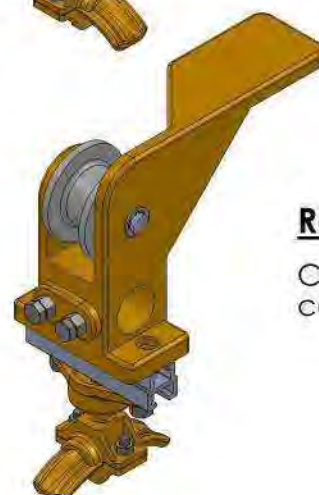
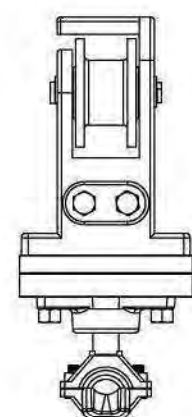

**Refª 124/130 ou 131**

Carro porta abraçadeira cabo redondo

1 2 3 4 5 6

### Grupo 215

Perfil metálico IPE

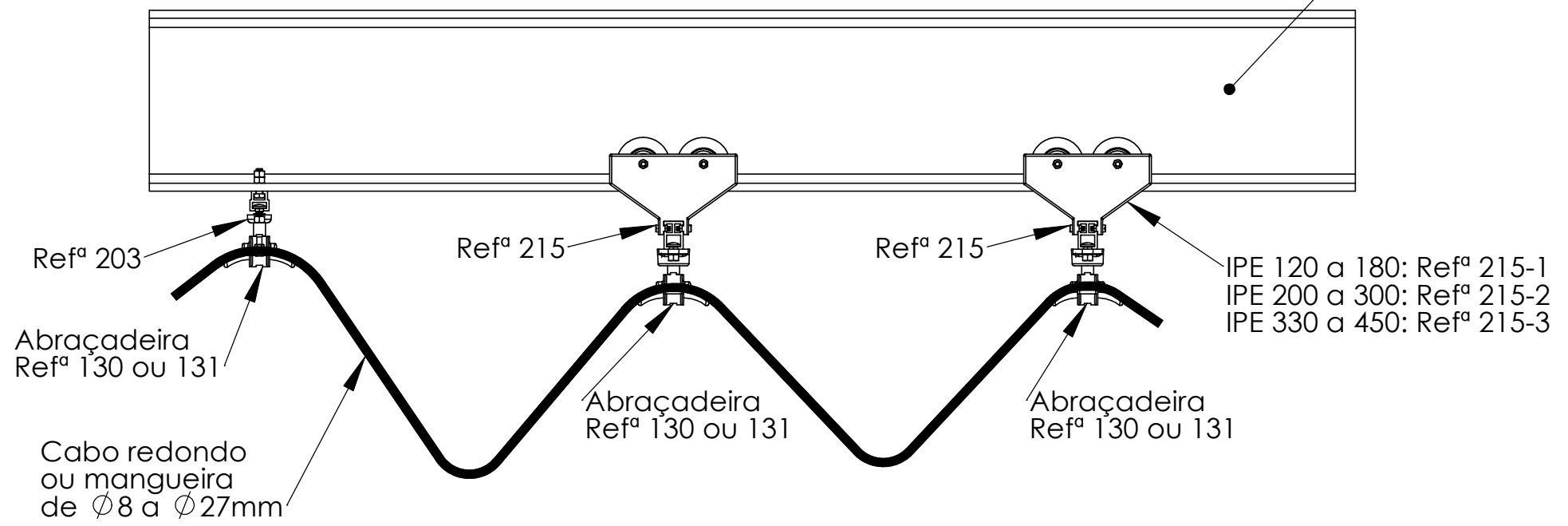

### Grupo 216

Perfil metálico IPE

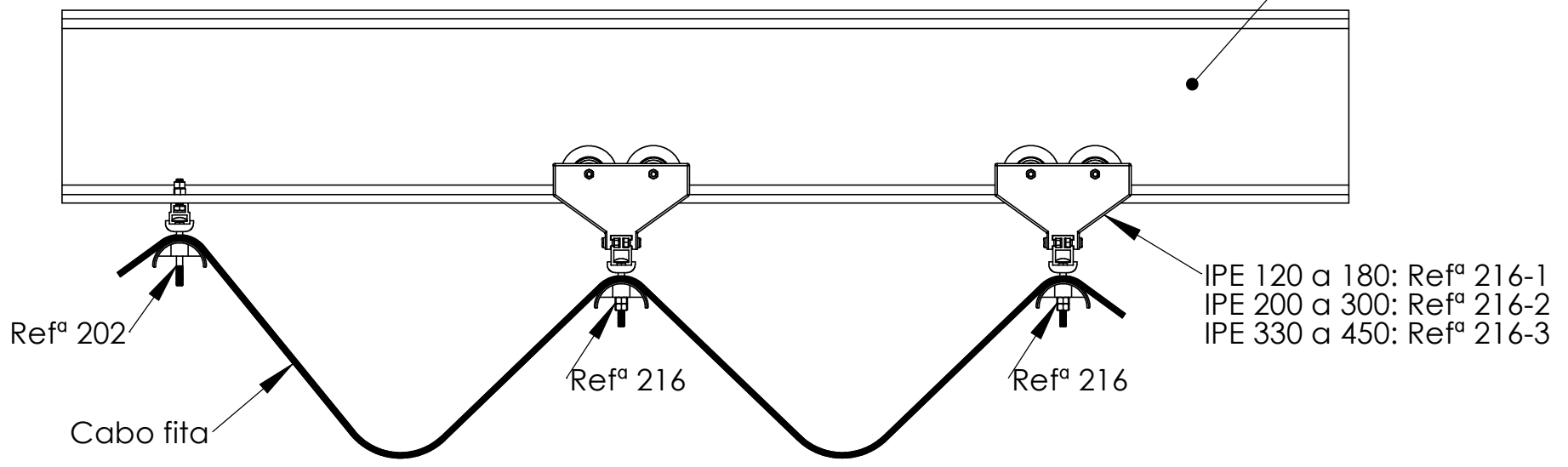

1 2 3 4 5 6

IPE 120 a 180: Refª 215-1  
 IPE 200 a 300: Refª 215-2  
 IPE 330 a 450: Refª 215-3

IPE 120 a 180: Refª 216-1  
 IPE 200 a 300: Refª 216-2  
 IPE 330 a 450: Refª 216-3



A

B

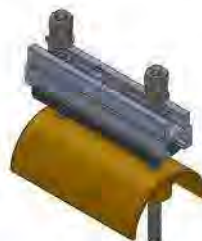
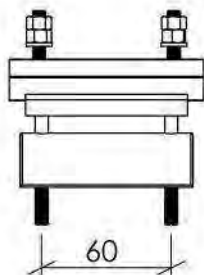
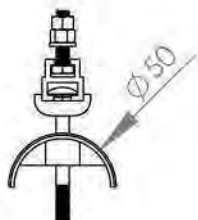

**Refª 202**

Fixador para cabo fita

C

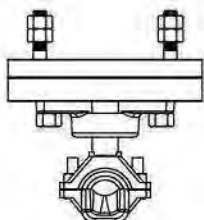
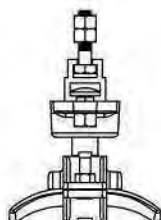

**Refª 203/130 ou 131**

Fixador para viga I com abraçadeira refª 130 ou 131

D

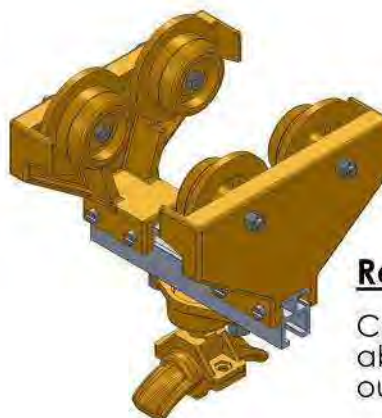
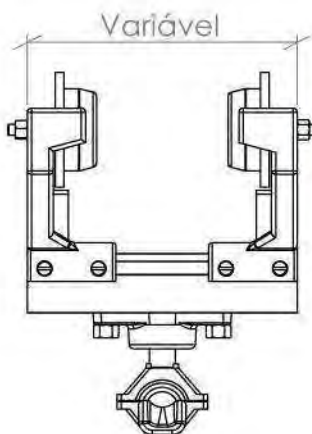
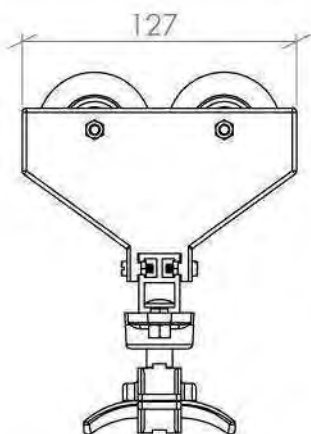

**Refª 215/130 ou 131**

Carro para viga I com abraçadeira refª 130 ou 131

E

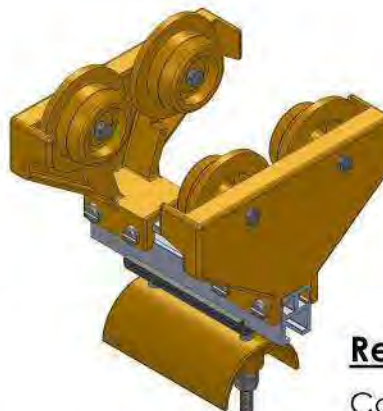
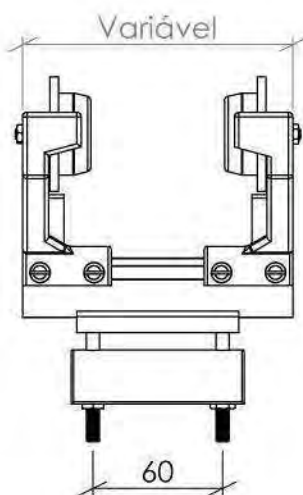
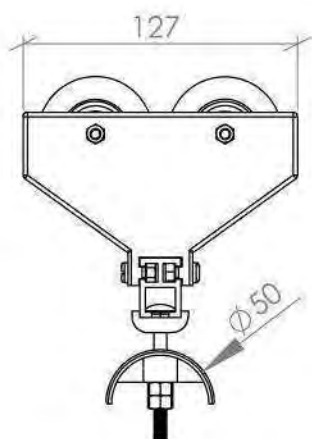

**Refª 216**

Carro para viga I com tambor

F

1 2 3 4 5 6

A

A

### Grupo 230

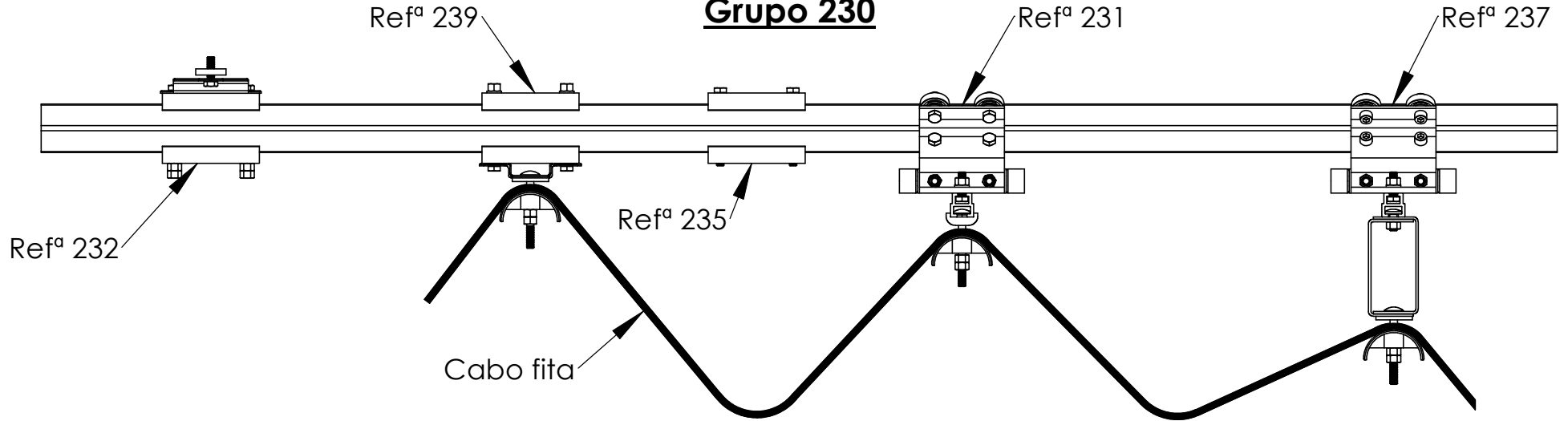

B

B

### Grupo 230-130

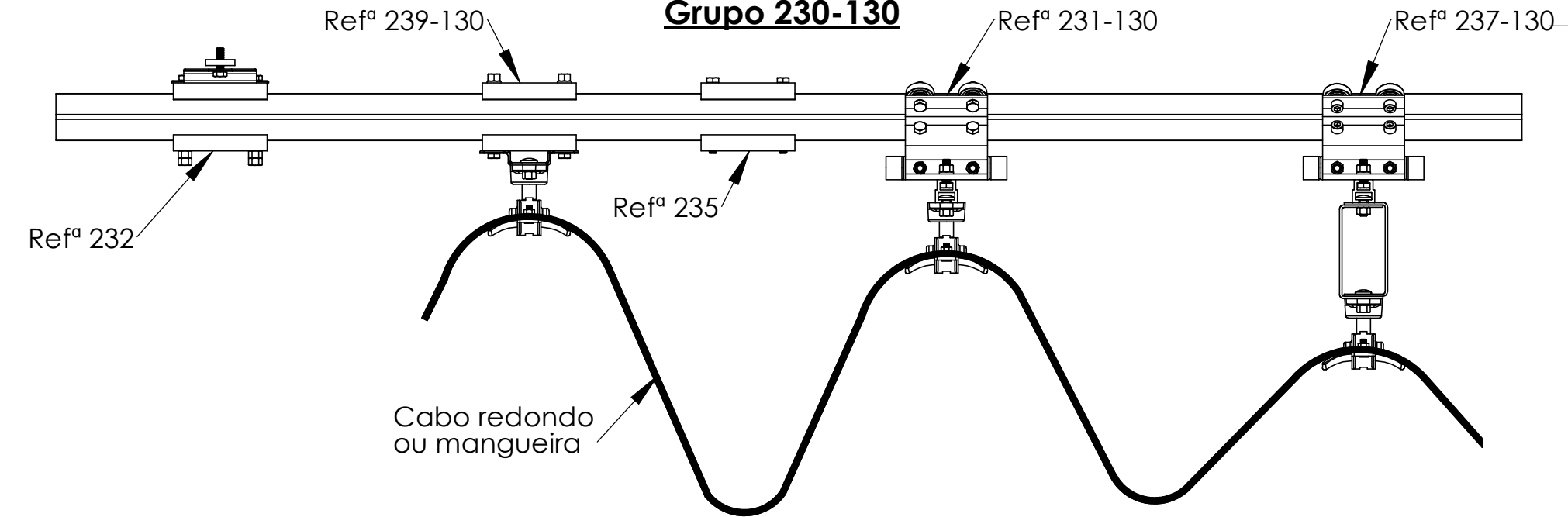

C

C

D

1 2 3 4 5 6

A  
B  
C  
D  
E  
F



**Tubo quadrado 30x30x2**

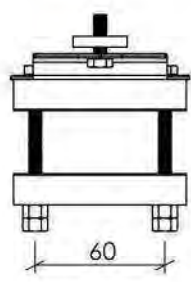
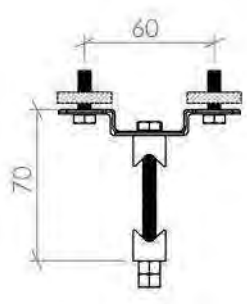

**Refª 232**

Suporte para tubo quadrado de 30mm

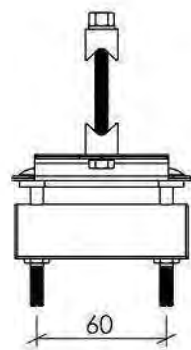
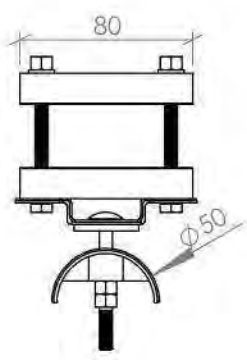

**Refª 239**

Fixador de cabo fita para tubo quadrado

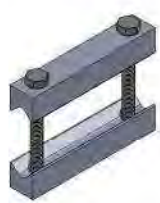
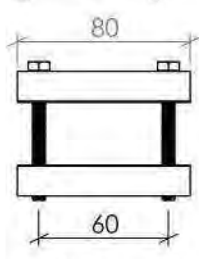
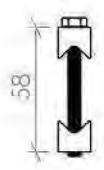

**Refª 235**

Junção para tubo quadrado de 30mm

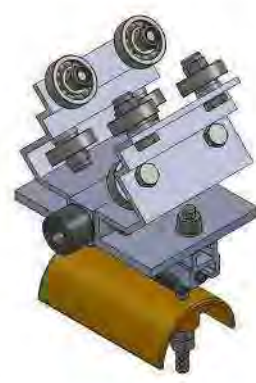
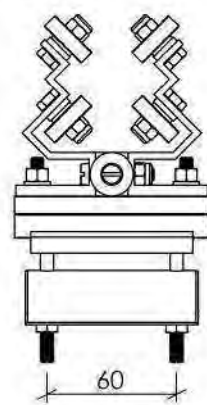
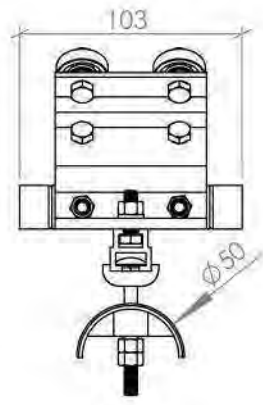

**Refª 231**

Carro p/ cabos intermédios p/ tubo quadrado de 30mm

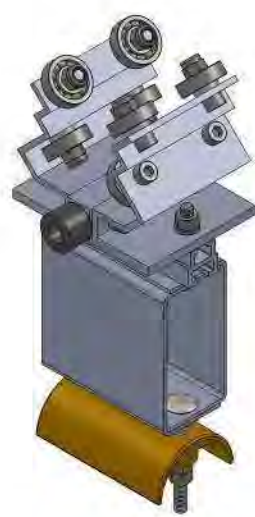
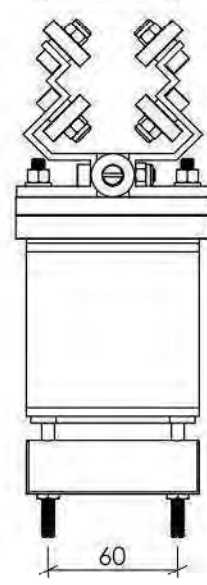
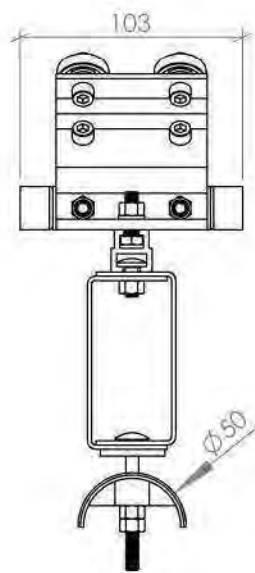

**Refª 237**

Carro p/ cabos guia p/ tubo quadrado de 30mm

A  
B  
C  
D  
E  
F



**Tubo quadrado 30x30x2**

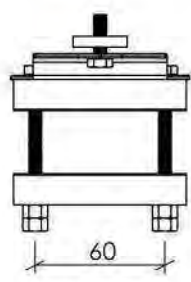
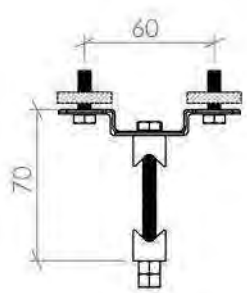

**Refª 232**

Suporte para tubo quadrado de 30mm

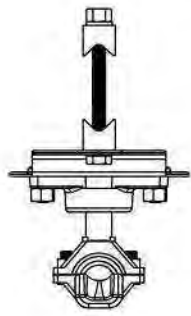
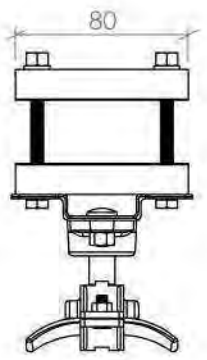

**Refª 239/130 ou 131**

Fixador de cabo redondo ou mangueira para tubo quadrado

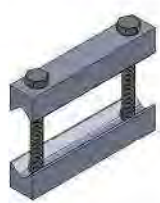
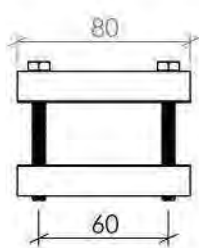
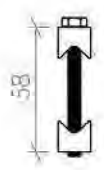

**Refª 235**

Junção para tubo quadrado de 30mm

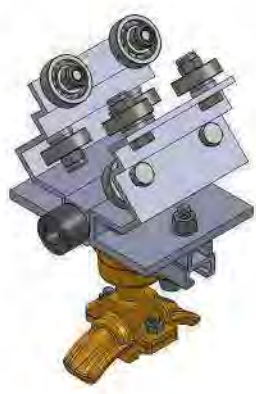
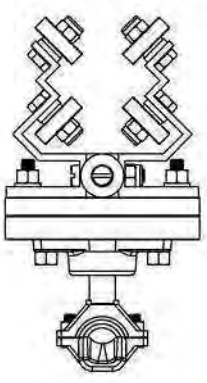
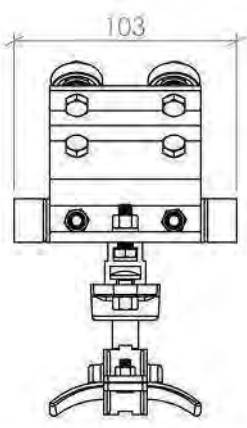

**Refª 231/130 ou 131**

Carro p/ cabos intermédios p/ tubo quadrado de 30mm

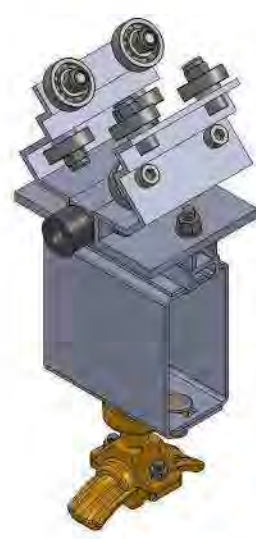
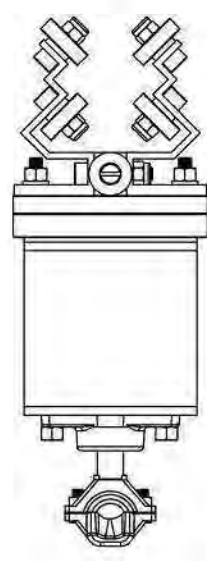
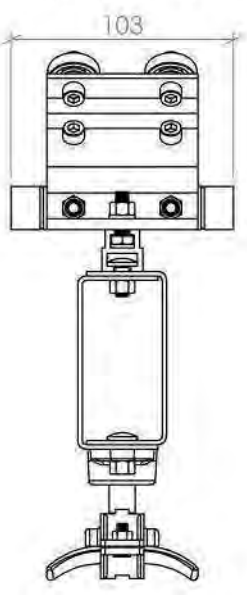

**Refª 237/130 ou 131**

Carro p/ cabos guia p/ tubo quadrado de 30mm

1 2 3 4 5 6

A

A

**Grupo240**

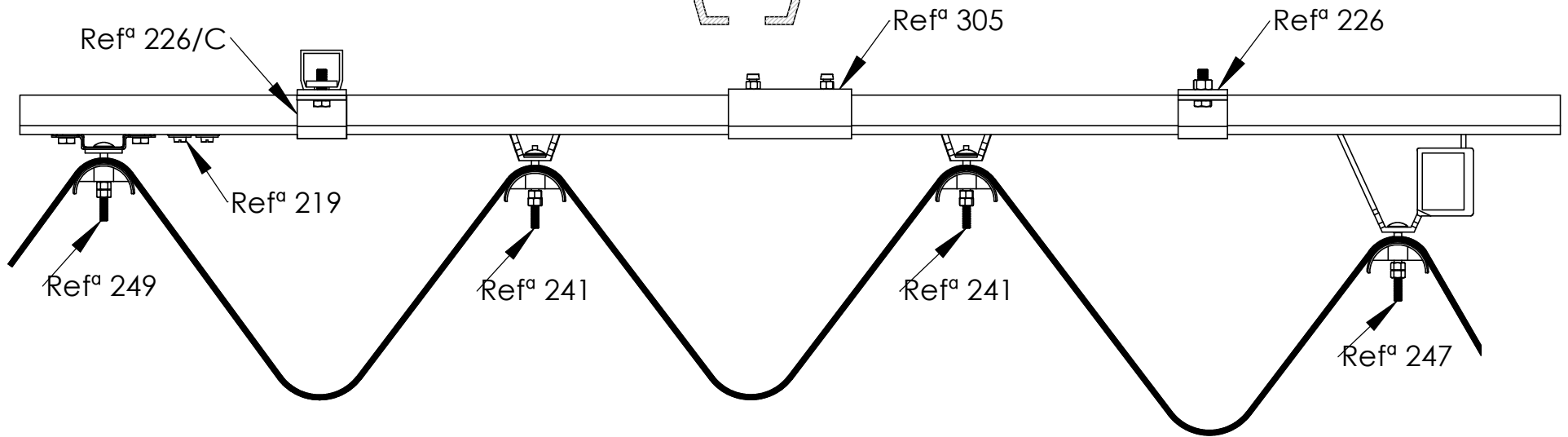

B

B

**Grupo 250**

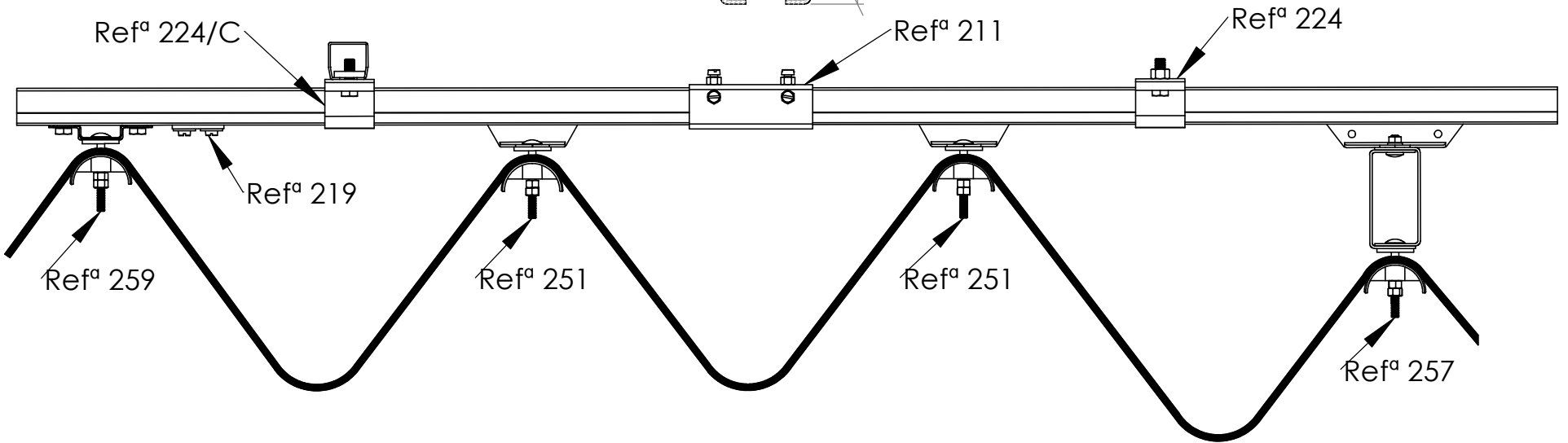
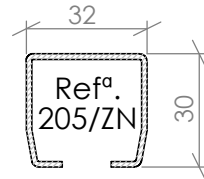

C

C

D

1 2 3 4 5 6

A

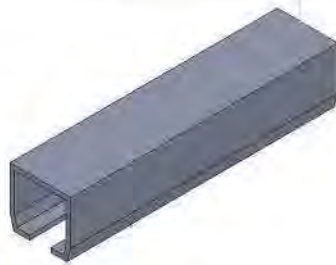
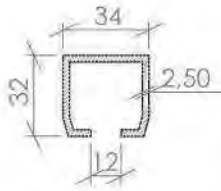

**Refª 205 / AL**

Calha de alumínio em comprimentos de 4 metros

B

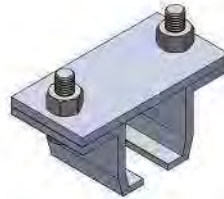
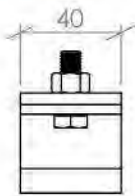
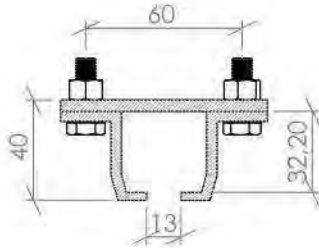

**Refª 226**

Suportes de calha afastados no máximo 1,50 metros

C

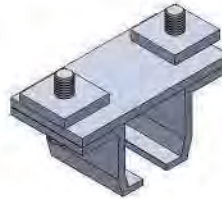
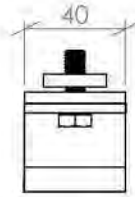
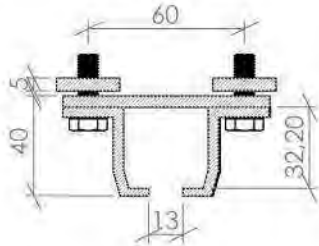

**Refª 226 / C**

Suportes de calha afastados no máximo 1,50 metros

D

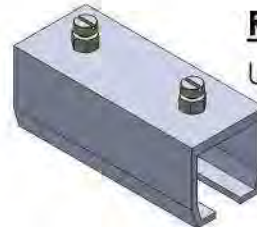
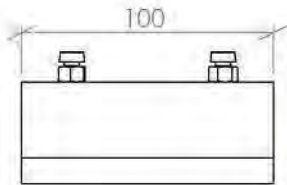
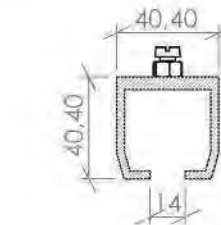

**Refª 305**

União de calha alumínio

E

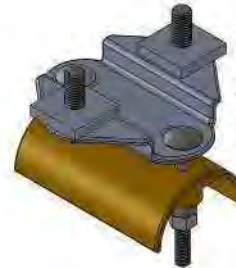
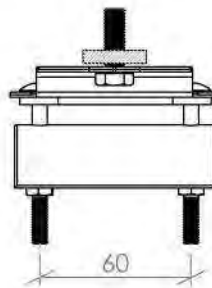
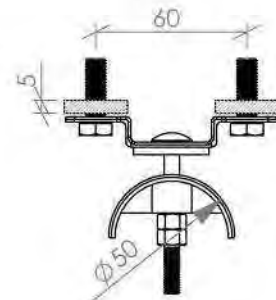

**Refª 249**

Fixador de cabo de fita

F

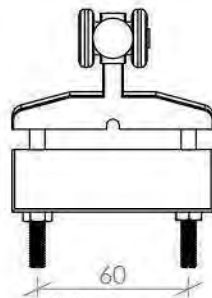
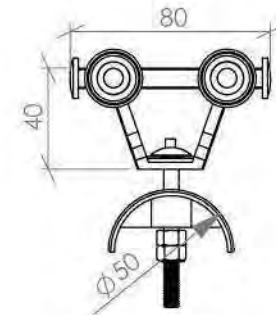

**Refª 241**

Carro porta cabos-fita intermédio

F

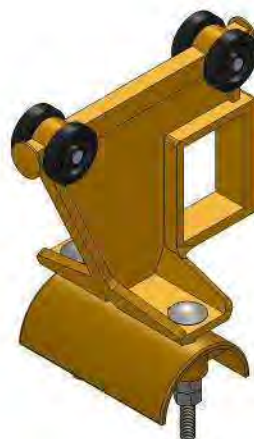
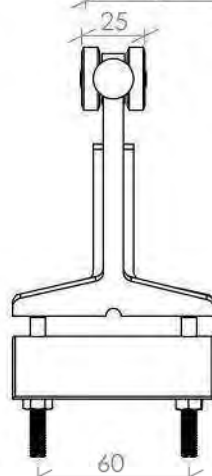
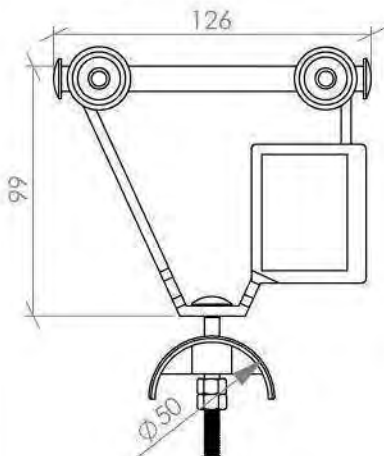

**Refª 247**

Carro porta cabos-fita guia

A

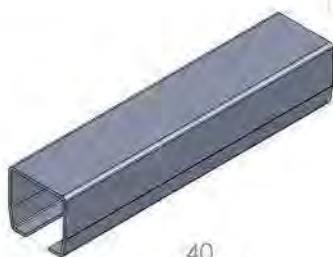
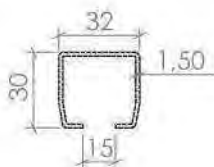
**Refª 205 / ZN**

Calha galvanizada em comprimentos de 4 metros

B

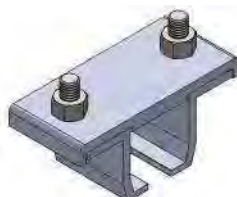
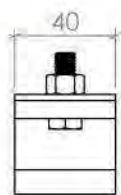
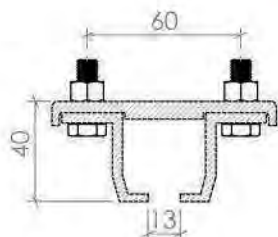
**Refª 224**

Suportes de calha afastados no máximo 1,50 metros

C

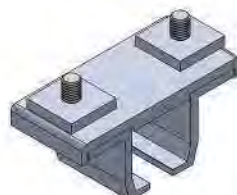
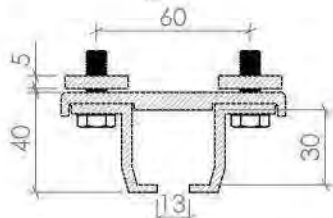
**Refª 224 / C**

Suportes de calha afastados no máximo 1,50 metros

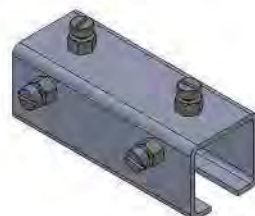
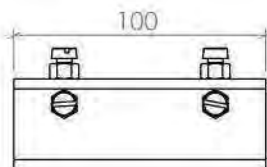
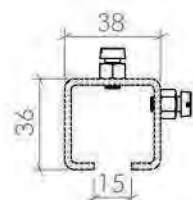
**Refª 211**

União de calha zincada

D

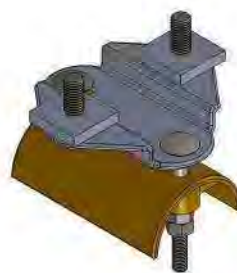
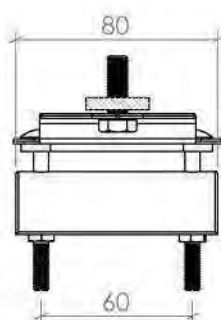
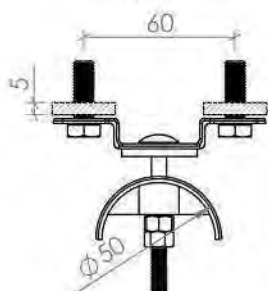
**Refª 259**

Fixador de cabo de fita

E

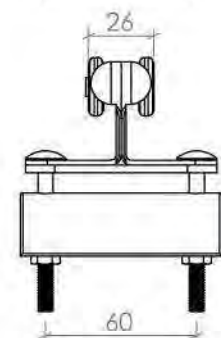
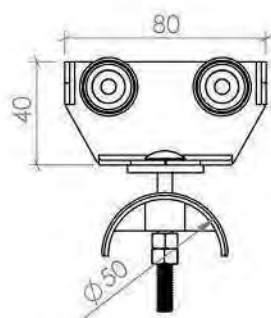
**Refª 251**

Carro porta cabos-fita intermédio

F

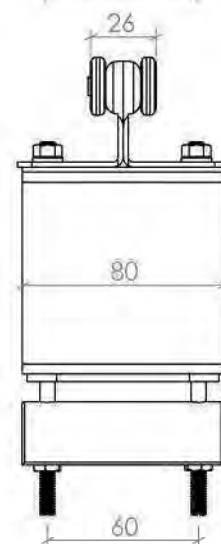
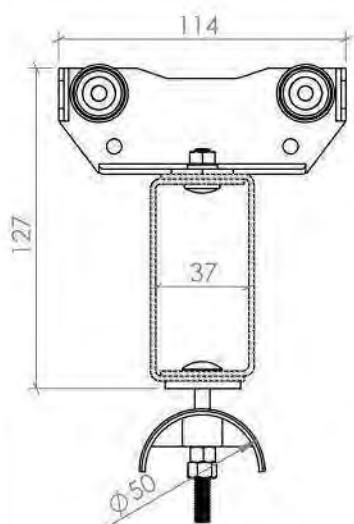
**Refª 257**

Carro porta cabos-fita guia

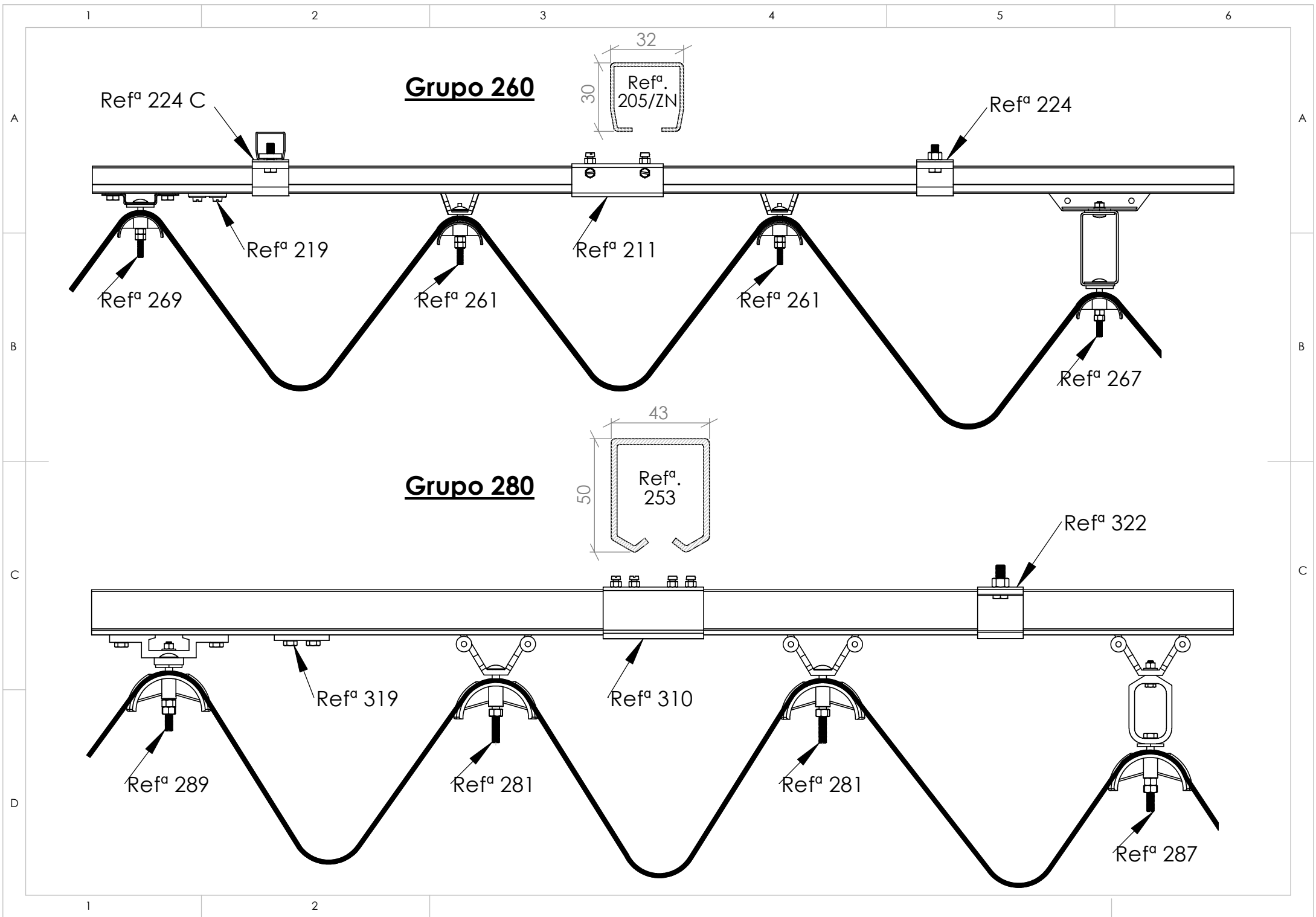

A

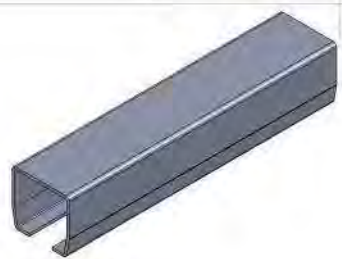
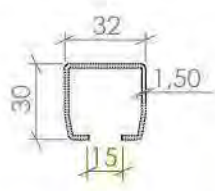

**Refª 205 / ZN**

Calha galvanizada em comprimentos de 4 metros

B

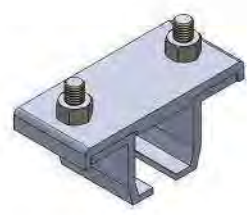
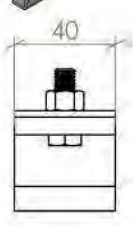
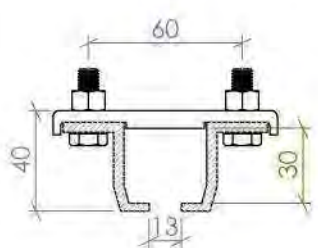

**Refª 224**

Suportes de calha afastados no máximo 1,50 metros

C

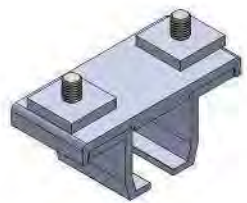
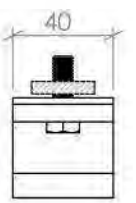
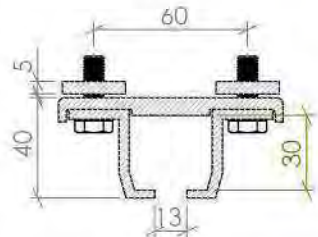

**Refª 224 / C**

Suportes de calha afastados no máximo 1,50 metros

D

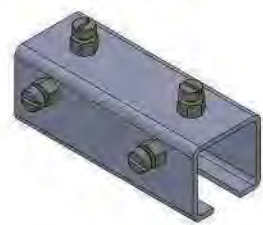
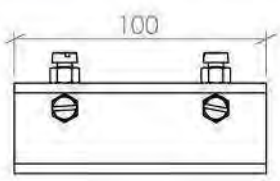
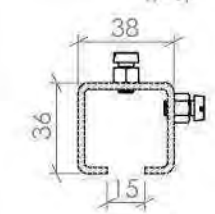

**Refª 211**

União de calha zincada

E

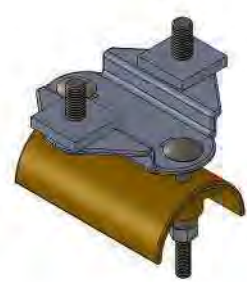
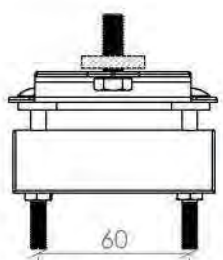
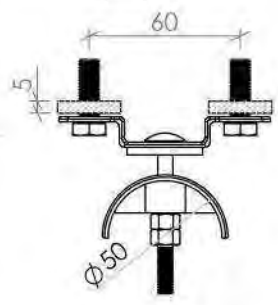

**Refª 269**

Fixador de cabo de fita

F

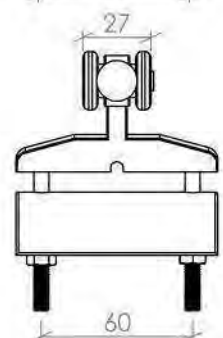
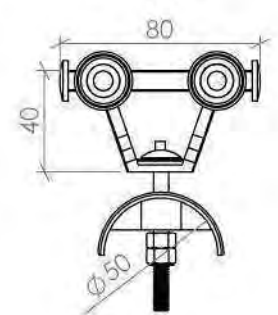

**Refª 261**

Carro porta cabos-fita intermédio

F

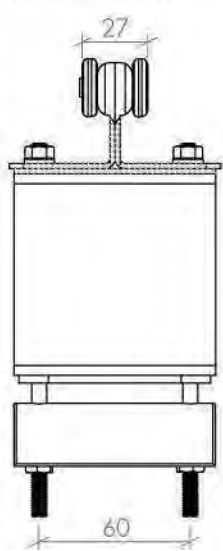
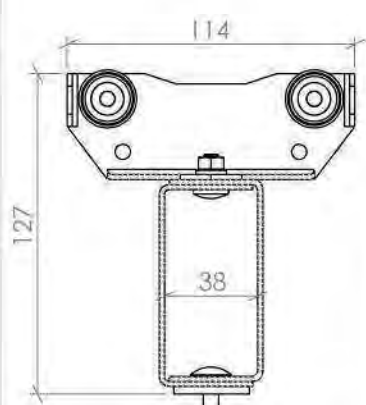

**Refª 267**

Carro porta cabos-fita guia

A

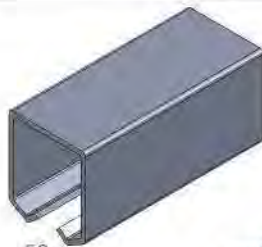
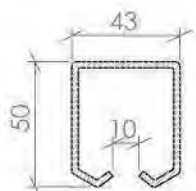
**Refª 253**

Calha de aço em comprimentos de 6 metros

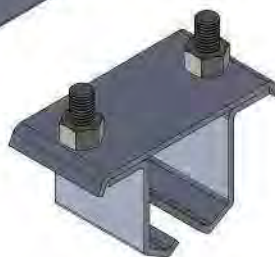
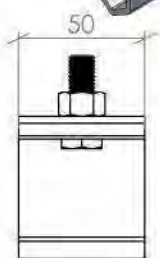
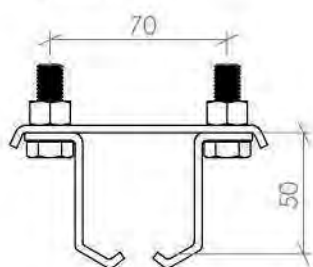
**Refª 322**

Suportes de calha afastados no máximo 2,00 metros

B

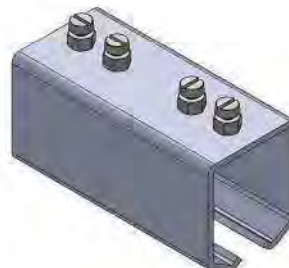
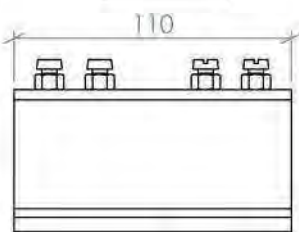
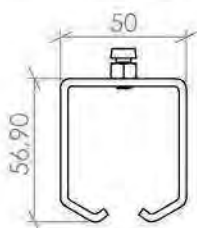
**Refª 310**

União de calha em aço

C

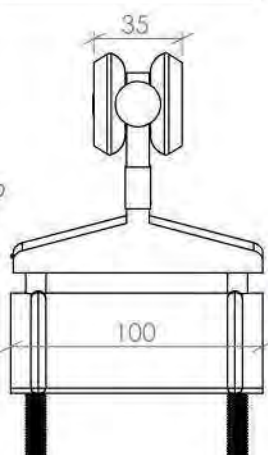
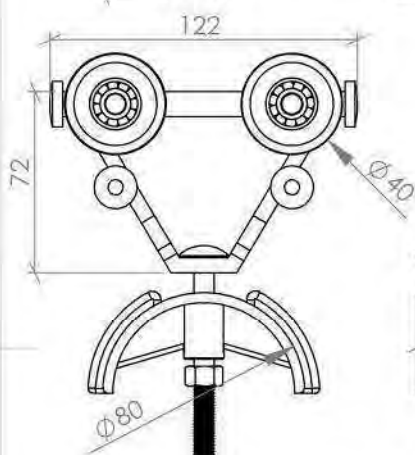
**Refª 281**

Carro porta cabos-fita intermédio

D

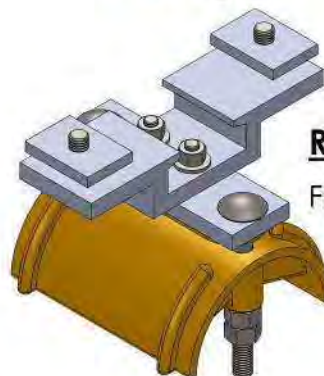
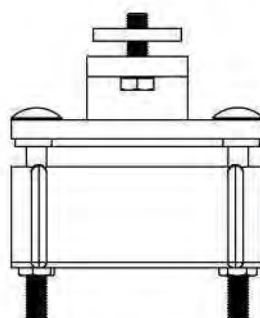
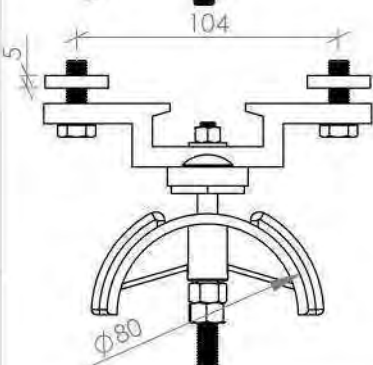
**Refª 289**

Fixador de cabo de fita

E

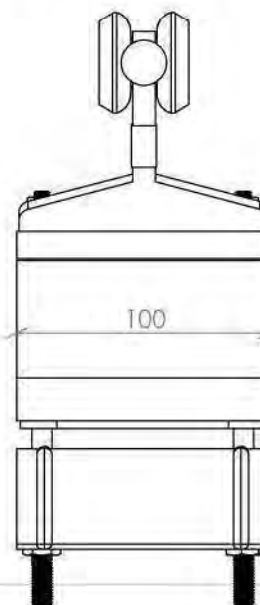
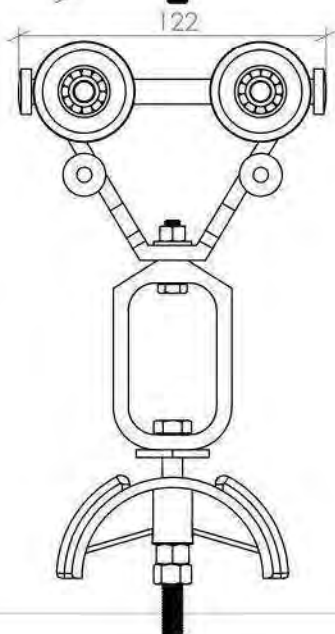
**Refª 287**

Carro porta cabos-fita guia

F

1 2 3 4 5 6

A

A

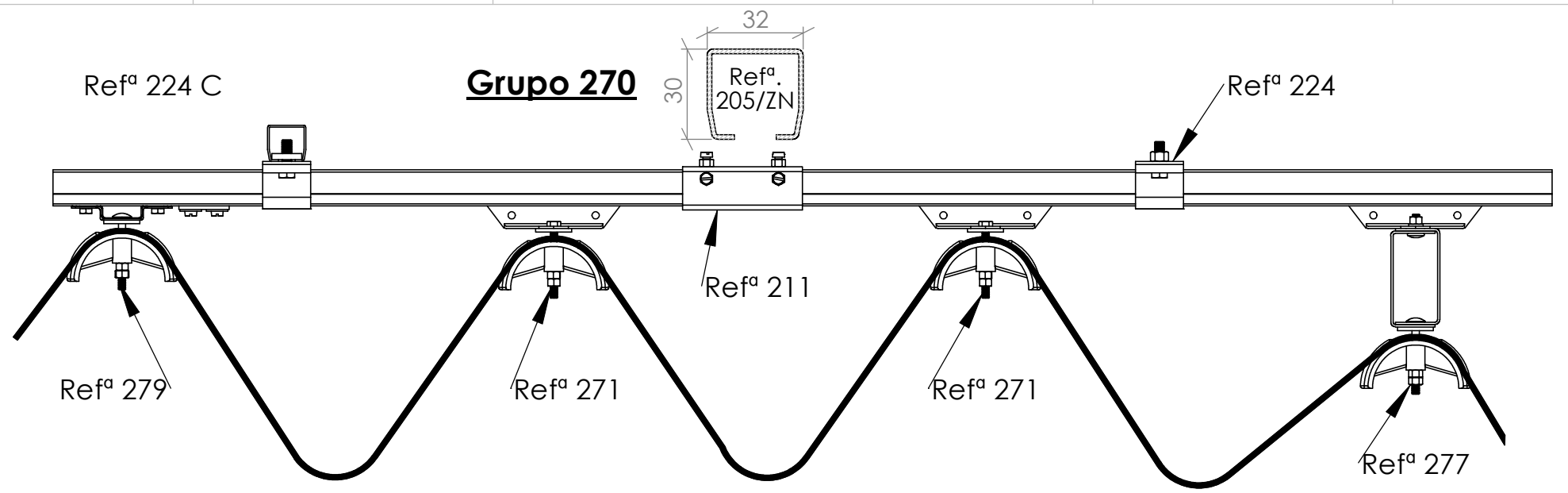

B

B

C

C

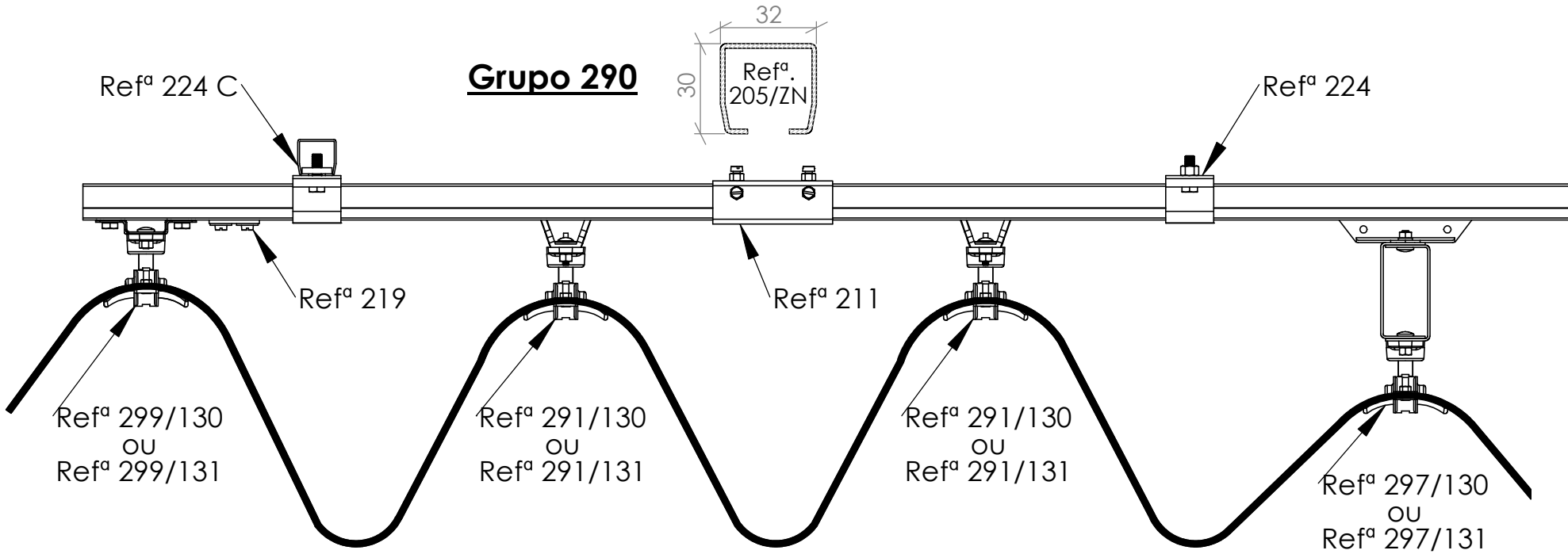

D

D

**Abraçadeiras Refª 130 - Cabos ou mangueiras  $\phi$  8 a  $\phi$  16mm**  
**Abraçadeiras Refª 131 - Cabos ou mangueiras  $\phi$  17 a  $\phi$  27mm**

1 2 3 4 5 6

A

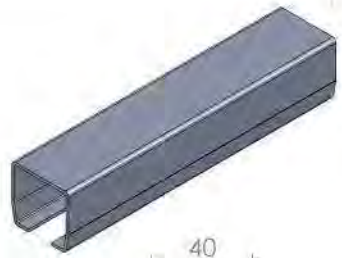
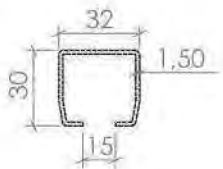

**Refª 205 / ZN**

Calha galvanizada em comprimentos de 4 metros

B

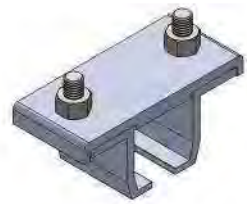
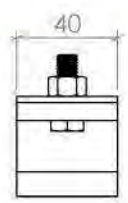
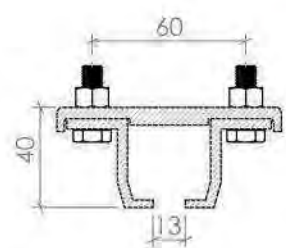

**Refª 224**

Suportes de calha afastados no máximo 1,50 metros

C

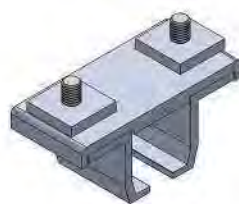
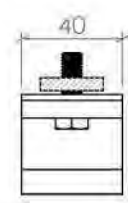
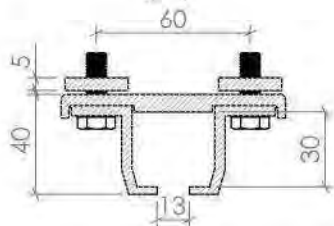

**Refª 224 / C**

Suportes de calha afastados no máximo 1,50 metros

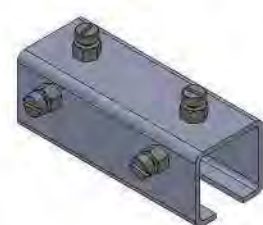
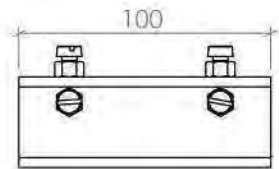
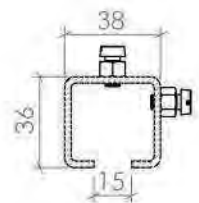

**Refª 211**

União de calha zincada

D

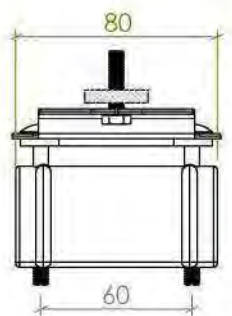
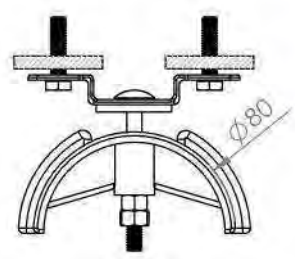

**Refª 279**

Fixador de cabo de fita

E

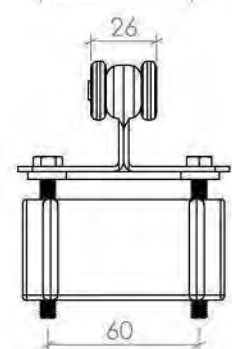
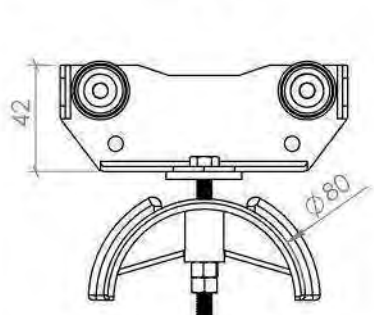

**Refª 271**

Carro porta cabos-fita intermédio

F

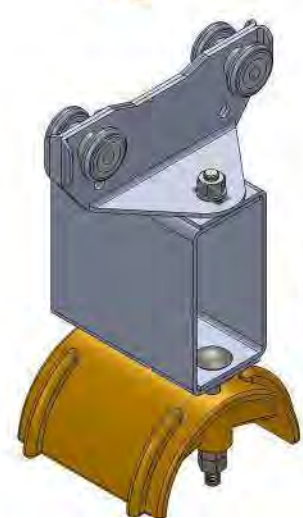
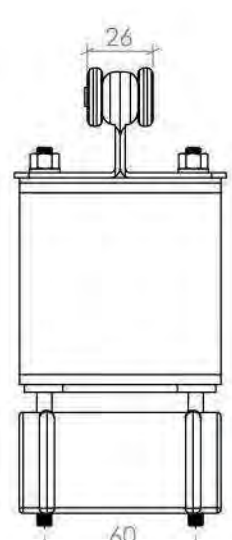
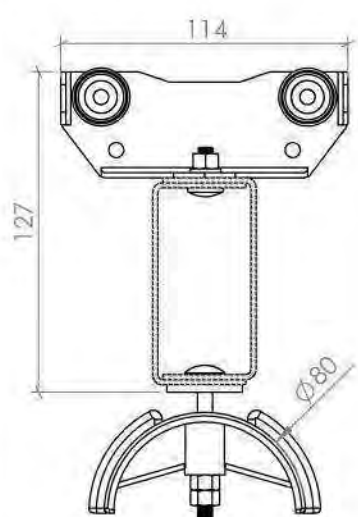

**Refª 277**

Carro porta cabos-fita guia

**Refª 205 / ZN**

Calha galvanizada em comprimentos de 4 metros

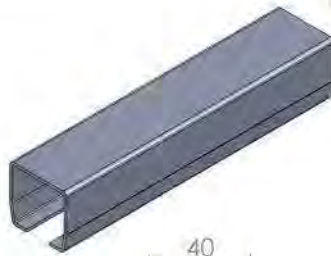
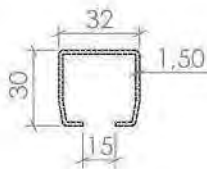
**Refª 224**

Suportes de calha afastados no máximo 1,50 metros

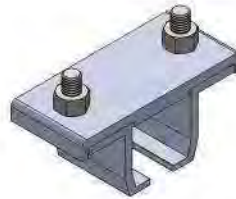
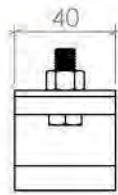
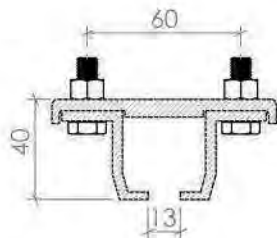
**Refª 224 / C**

Suportes de calha afastados no máximo 1,50 metros

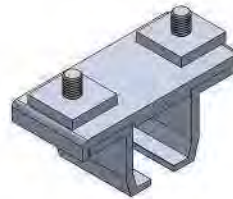
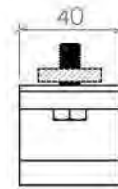
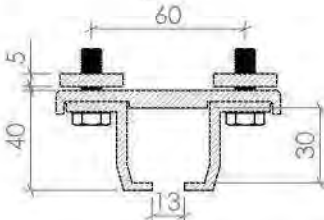
**Refª 211**

União de calha zincada

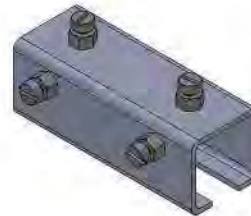
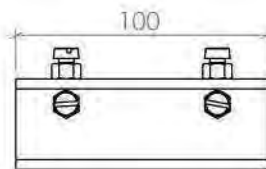
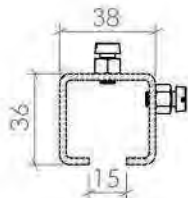
**Refª 299**

Fixador de abraçadeira cabo de redondo

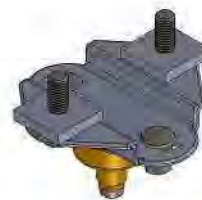
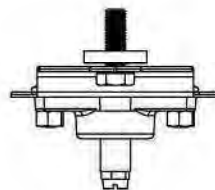
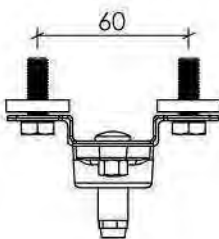
**Refª 291**

Carro porta abraçadeira cabo redondo

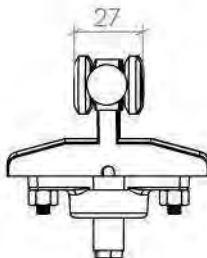
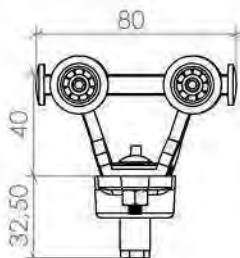
**Refª 297**

Carro porta abraçadeira cabo redondo guia

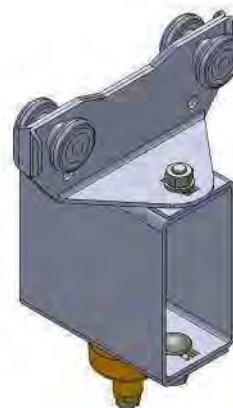
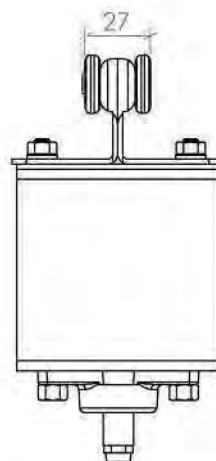
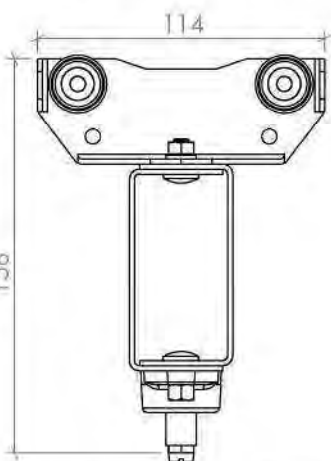

F

**Refª 130**

Abraçadeira  $\varnothing$  8 a 16mm

**Refª 131**

Abraçadeira  $\varnothing$  17 a 27mm

**Refª 291/131/130**