

---

# PORSÄ KUBUS

---

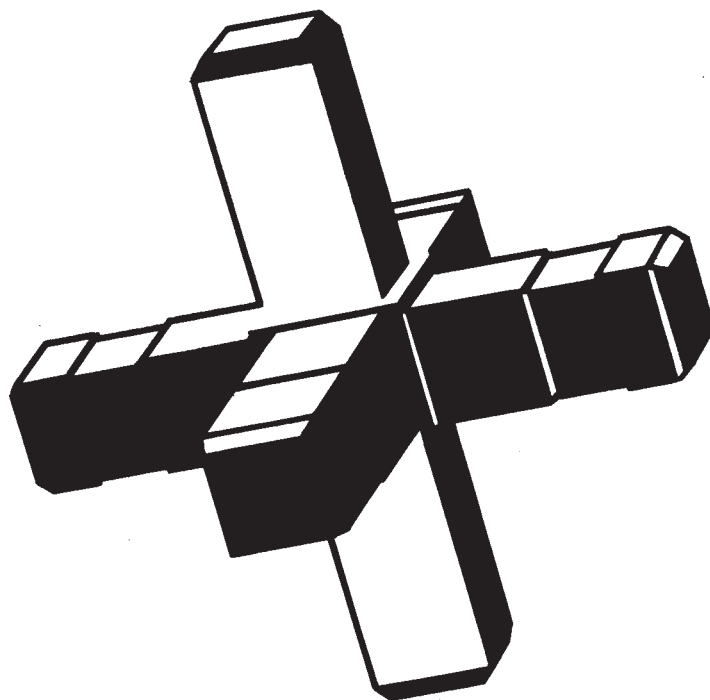

Il sistema modulare componibile "PORSÄ KUBUS" è costituito da profilati in alluminio con sezione quadrata mm 25x25 ed elementi d'assemblaggio ad incastro.

È il più indicato per le realizzazioni semplici e lineari quali: vetrinette, espositori, carrelli etc.



PORSA KUBUS - Strutture



PORSA KUBUS - Strutture



PORSA KUBUS - Scaffale



PORSA KUBUS - Tavolini e carrello



PORSA KUBUS - Negozio abbigliamento



PORSA A + PORSA LET - Parete attrezzata

---



PORSA KUBUS - Vetrina



PORSA KUBUS - Vetrina



PORSA KUBUS - Vetrina

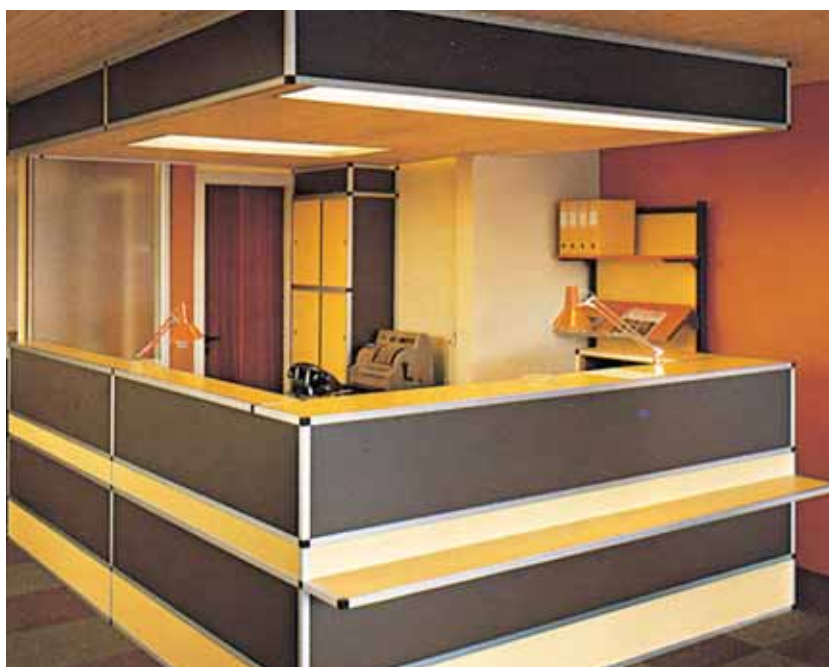

PORSA KUBUS - Reception

Giunti con anima in alluminio  
pressofuso rivestiti da una mescola di  
materiale plastico antiurto

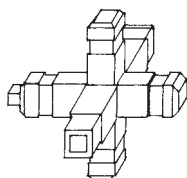
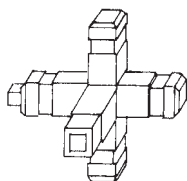
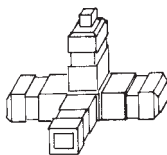
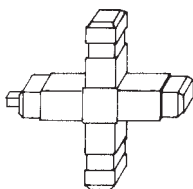
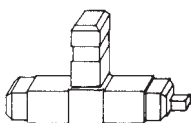
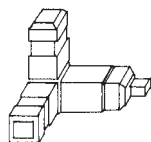
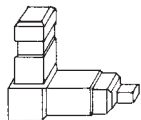

codice

**K.2000**

**K.2001**

**K.2002**

**K.2003**

**K.2004**

**K.2005**

**K.2006**

**K.2007**

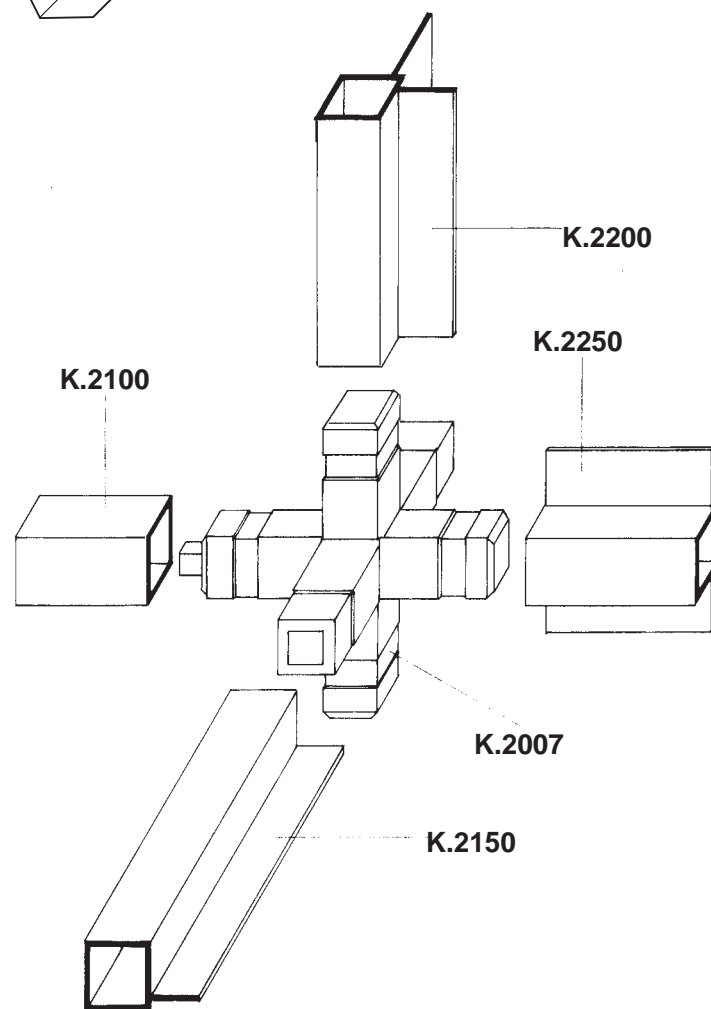
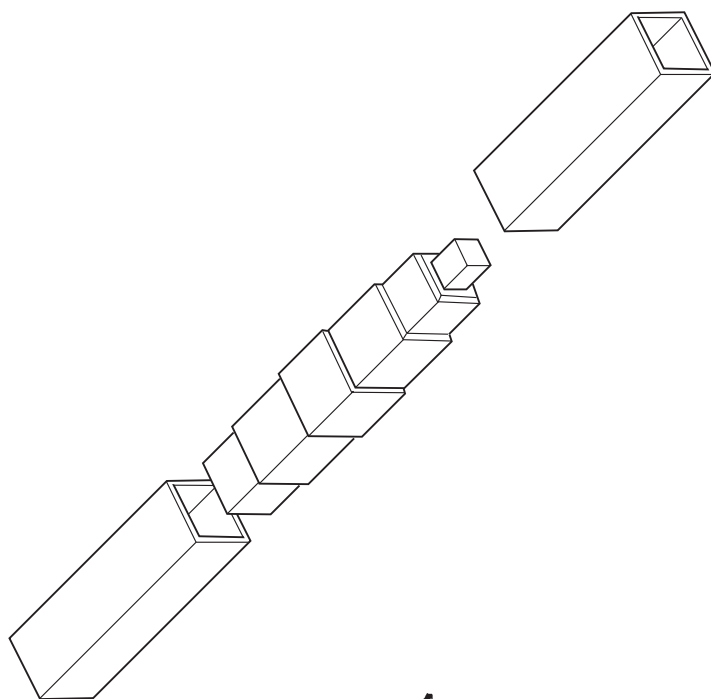

Giunti in Moplen senza anima in alluminio.  
Adatti ad impieghi poco gravosi.

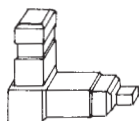

codice

**K.2001/P**

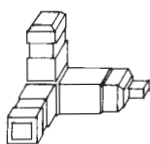

**K.2002/P**

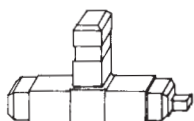

**K.2003/P**

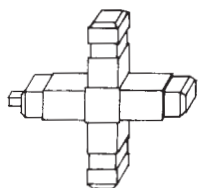

**K.2004/P**

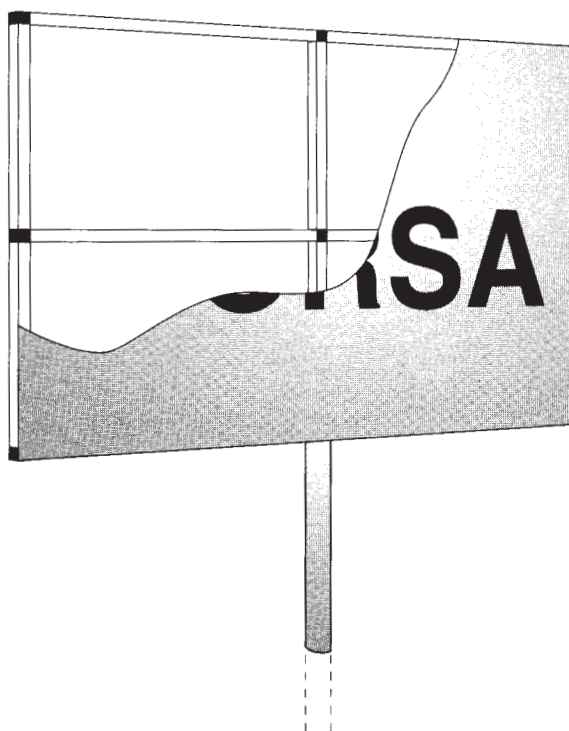

codice

Giunti con anima in alluminio  
pressofuso forati per l'inserimento di  
inserto in ottone filettato 10MA abbinato  
al giunto

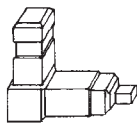
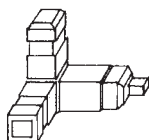
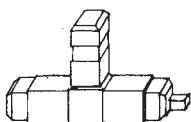
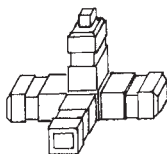
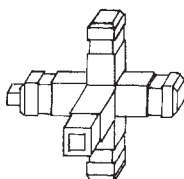
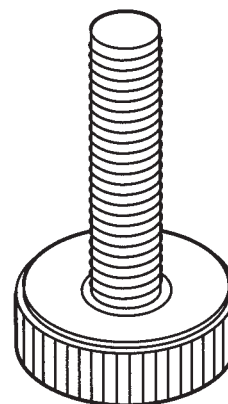
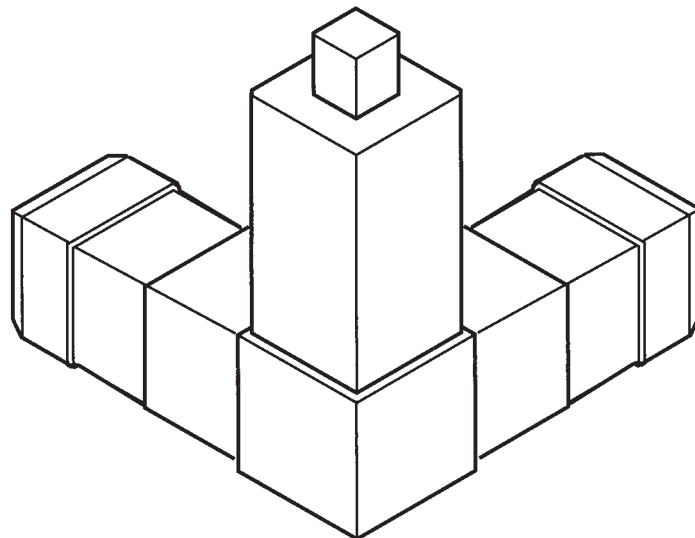
**K.2001/F**

**K.2002/F**

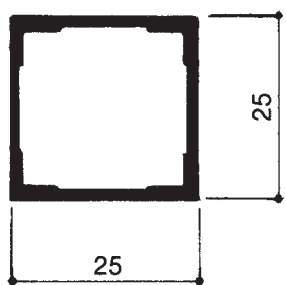
**K.2003/F**

**K.2005/F**

**K.2006/F**

Profilo in alluminio estruso a sezione quadrata (lunghezza mm 6000)



codice

**K.2100**

Profilo in alluminio estruso a sezione quadrata con aletta (lunghezza barre mm 6000)

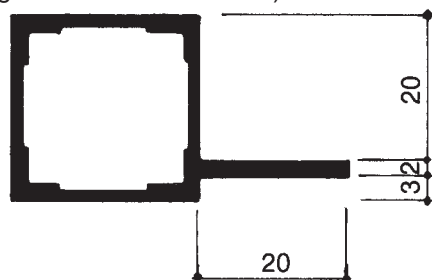

**K.2150**

Profilo in alluminio estruso a sezione quadrata con due alette a 90° (lunghezza barre mm 6000)

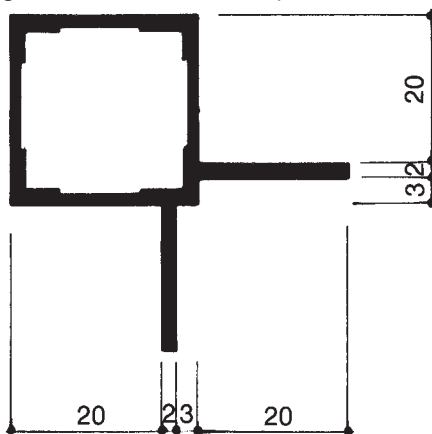

**K.2200**

Profilo in alluminio estruso a sezione quadrata con tre alette (lunghezza barre mm 6000)

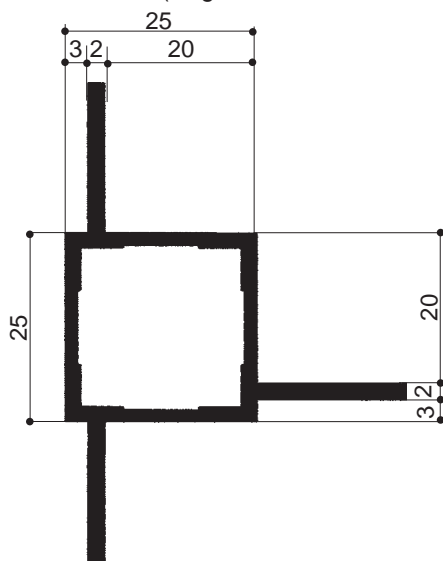

**K.2180**

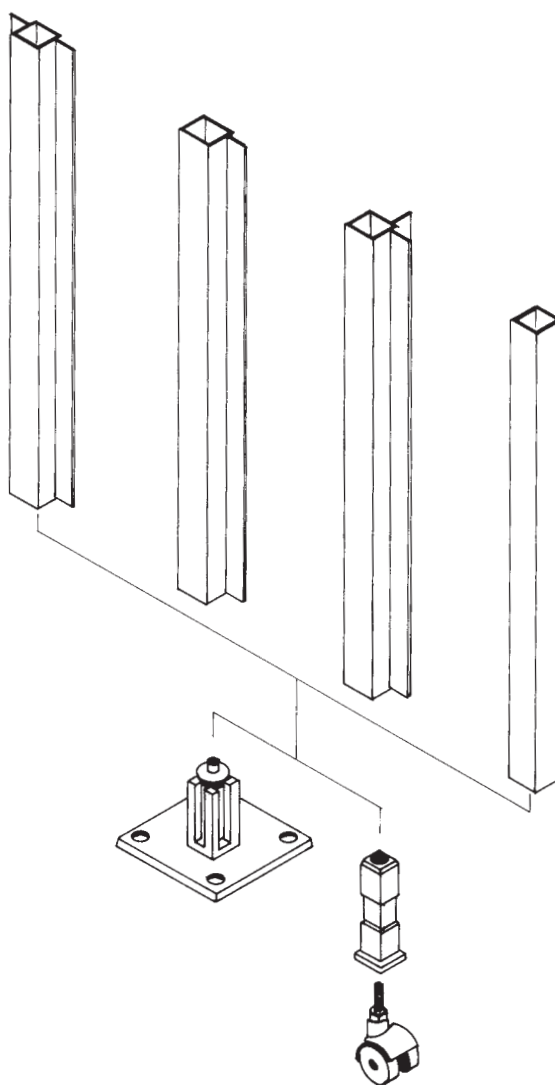

Profilo in alluminio estruso a sezione quadrata con due alette 180°  
(lunghezza barre mm 6000)

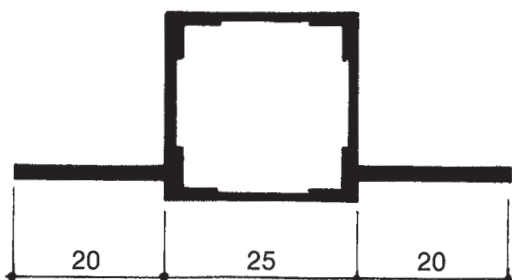

Profilo in alluminio estruso a sezione quadrata con 2 alette esterne a 90°.  
(lunghezza barre mm 6000)

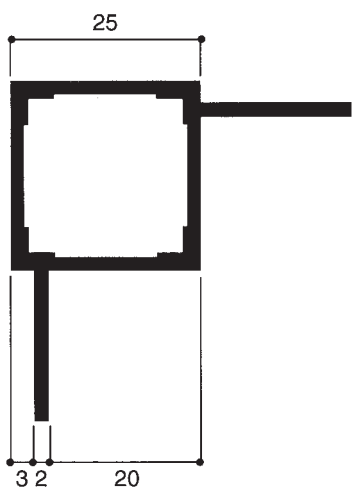

Profilo in alluminio estruso a sezione quadrata con 2 alette a 90° di cui 1 esterna ed 1 interna.  
(lunghezza barre mm 6000)

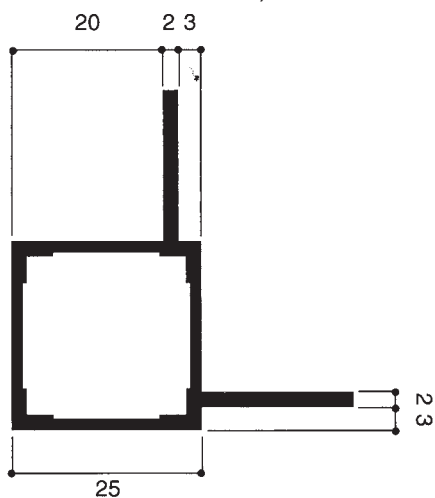

codice

**K.2250**

**K.2160**

**K.2170**

